

16mm Snap-in Insulated Shaft Potentiometers

SP16H



Part Number

SP16H - B **50K**, L - **20** **F**
 ↓ ↓ ↓ ↓
 Taper Resistance Value Shaft Length Shaft Type

Dimensions

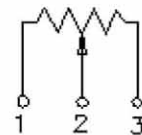
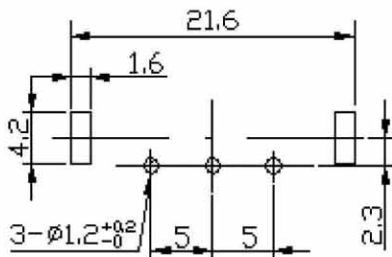
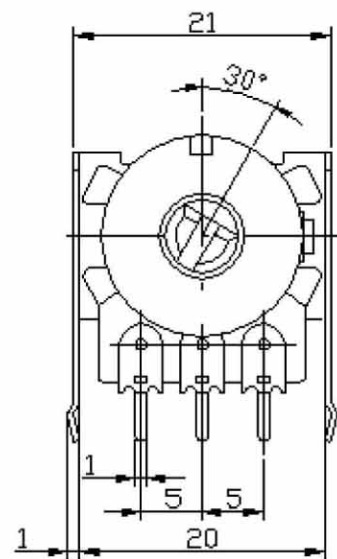
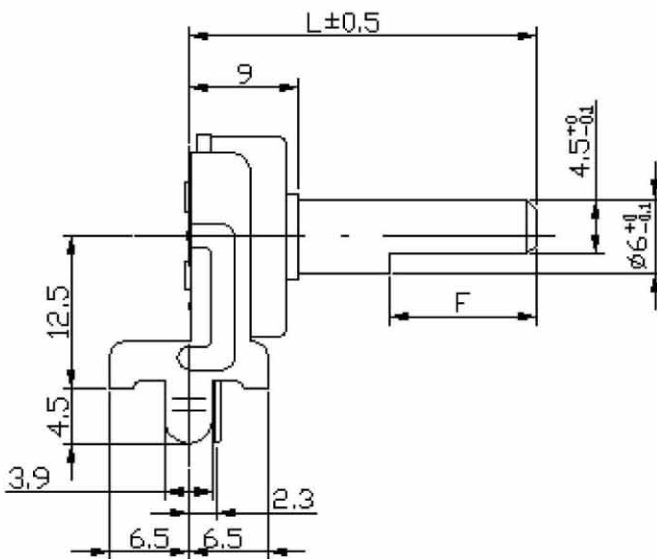

16mm Snap-in Insulated Shaft Potentiometers

Shaft Dimensions

KC TYPE
18TEETH

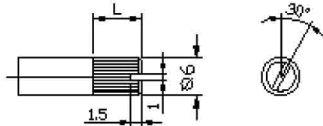

SHAFT SHOWN IN
FULL C.C.W. POSITION

HORIZONTAL WITH BUSHING

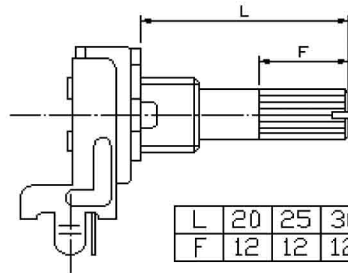

F Type

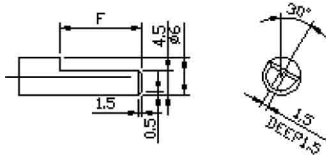

SHAFT SHOWN IN
FULL C.C.W. POSITION

F Type

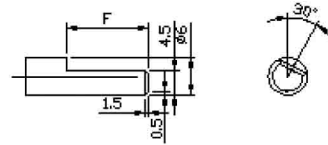

SHAFT SHOWN IN
FULL C.C.W. POSITION

Horizontal with bushing

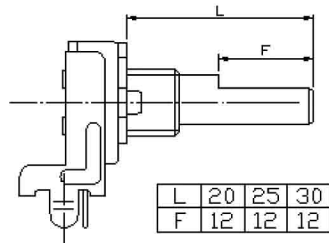

Bushing Dimension

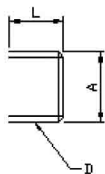

L	A	D	
7	ø9	M9x0.75	STD

Stopper Dimension

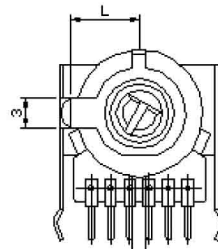

L	
9	SATNDARD