

16mm Snap-in Insulated Shaft Potentiometers

R1612G



Part Number

R1612G - B 50K, L - 20 F

↓ Taper ↓ Resistance Value ↓ Shaft Length ↓ Shaft Type

Dimensions

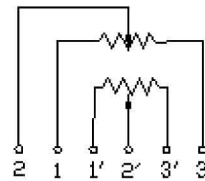
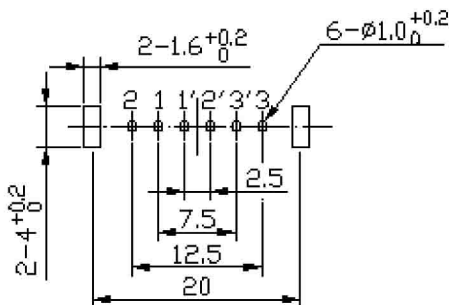
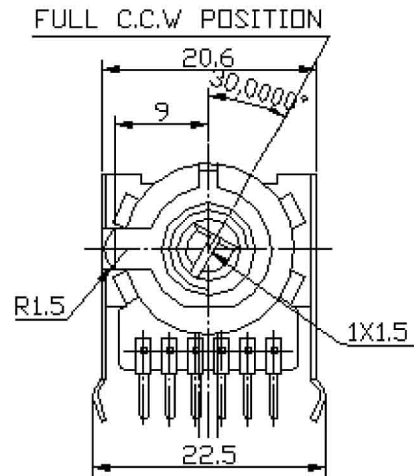
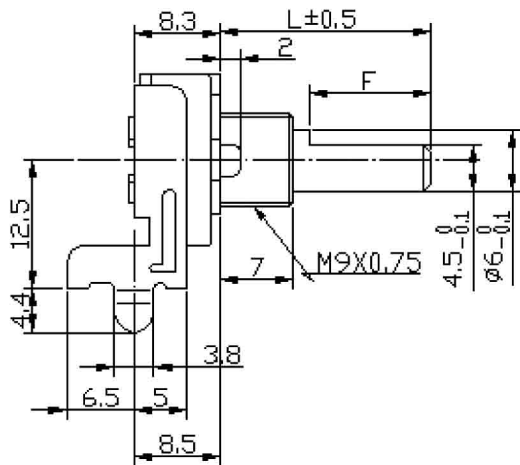

16mm Snap-in Insulated Shaft Potentiometers

Shaft Dimensions

KC TYPE
18TEETH

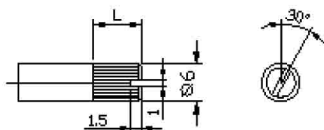

SHAFT SHOWN IN
FULL C.C.W. POSITION

HORIZONTAL WITH BUSHING

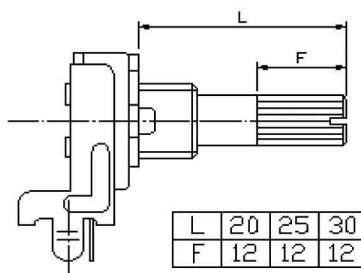

F Type

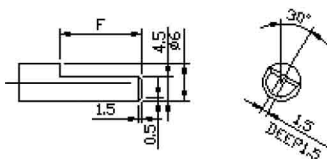

SHAFT SHOWN IN
FULL C.C.W. POSITION

F Type

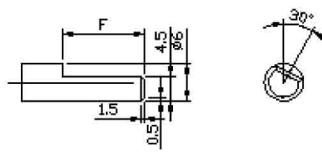

SHAFT SHOWN IN
FULL C.C.W. POSITION

Horizontal with bushing

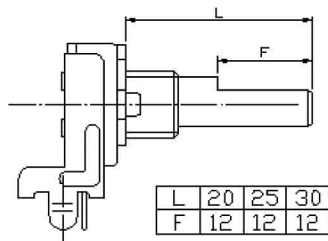

Bushing Dimension

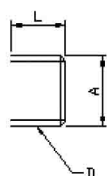

L	A	D	
7	∅9	M9x0.75	STD

Stopper Dimension

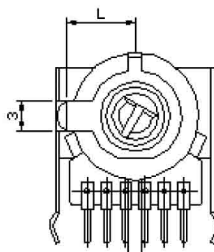

L	
9	SATNDARD