

KTL030FCI-U-24V

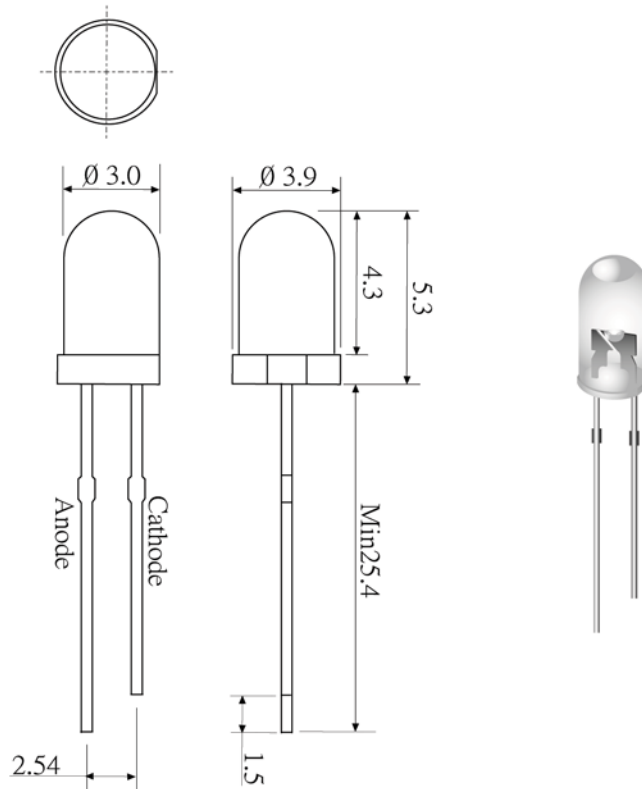

- * 3mm with Ultra Bright Orange dice with 24v Resister.
- * Encapsulated with Water Clear package.
- * long leads.

Absolute Maximum Ratings:

Parameter	Maximum Rating	Unit
Peak Forward Current	120	mA
Continuous Forward Current	30	mA
Operating temperature Range	-20C + 75C	
Storage Temperature Range	-40C + 100C	
Lead Soldering Temperature	260C for 5 seconds	

Electre-Optical Characterature (Ta=25C)

Parameter	Radiant	Test Condition	Symbol	Min.	Typ.	Max.	Unit
Forward Voltage		If=10mA	Vf		24		V
Reverse Current		Vr=5V	Ir			10	uA
Luminous Intensity		If=10mA	Iv		2500		mcd
Spectral Bandwidth		If=10mA	$\Delta \lambda$		30		nm
Wavelength		If=10mA	λ_p		605		nm
			λ_d		608		nm
Half View Angle		If=10mA	2 θ 1/2		30		deg