

ALLOWANCE			MARK	DATE	DESCRIPTION OF REVISION	APPROVED
UNDER 3	± 0.1	△	. .			
3 TO 6	± 0.2	△	. .			
6 TO 18	± 0.3	△	. .			
18 TO 50	± 0.4	△	. .			
50 OVER	± 0.5	△	. .			

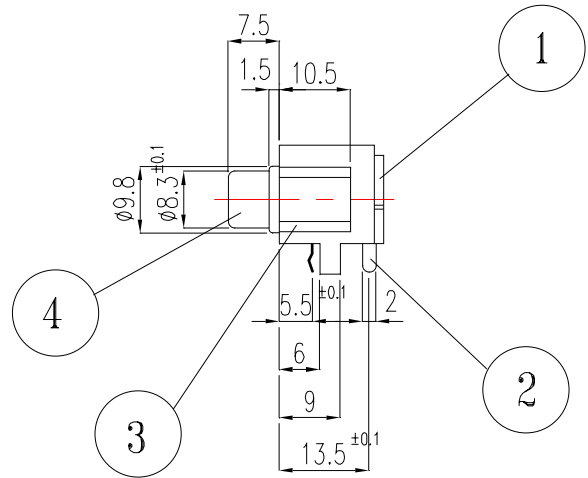

"E" DETAIL 2/1

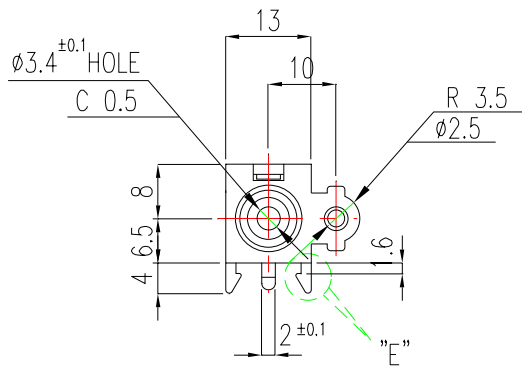
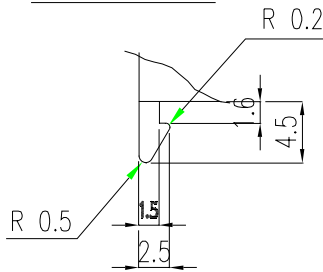

SCHEMATIC

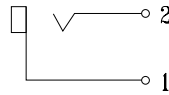

PCB-MTG

(Solder Surface)

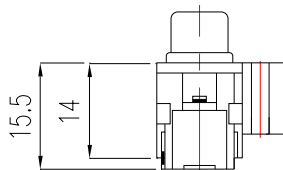
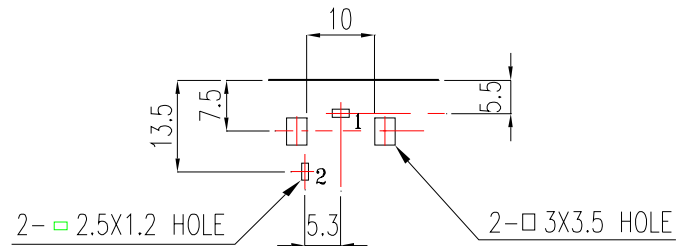

4	CAP-GROUND	C2600 1-0	0.4t	1	1P146	AU-PLATING
3	COVER	ACETAL		1	2M755	BLACK
2	PIN-S	C2680 H	0.5t	1	2P147	NI-PLATING
1	BASE	ACETAL		1	2M719	BLACK
NO	PART NAME	MATERIAL		QUANTITY	PART NO	REMARKS

Vimex International Corp.
800-227-0075

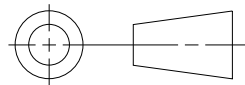

SCALE

1/1

DIMENSION m/m

REVISION	DRAWING	CHECKED	APPROVED	NAME TITLE	PIN JACK BOARD(1P)
1.0	L.M.S			DRAWING NUMBER	
	2001.01.08	2001.01.08	2001.01.08		JC010126BG