

ALLOWANCE	MARK	DATE	DESCRIPTION OF REVISION	APPROVED
UNDER 3	± 0.1	△	. .	
3 TO 6	± 0.2	△	. .	
6 TO 18	± 0.3	△	. .	
18 TO 50	± 0.4	△	. .	
50 OVER	± 0.5	△	. .	

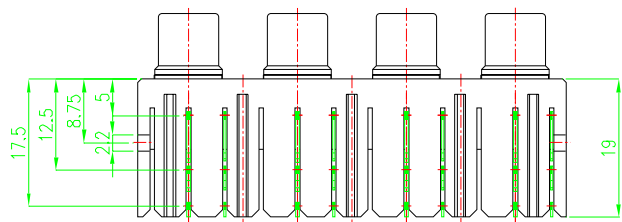

PCB-MTG
(Solder surface)

SCHMATIC

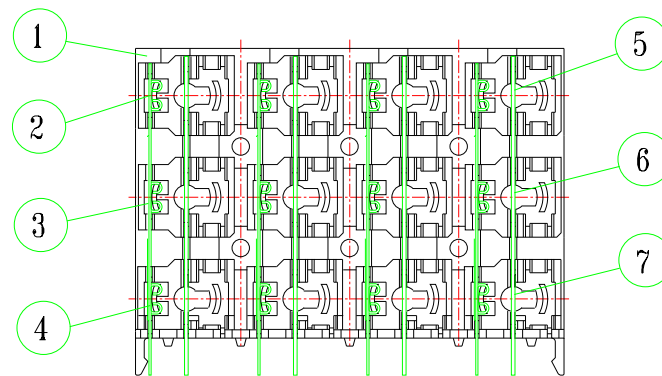
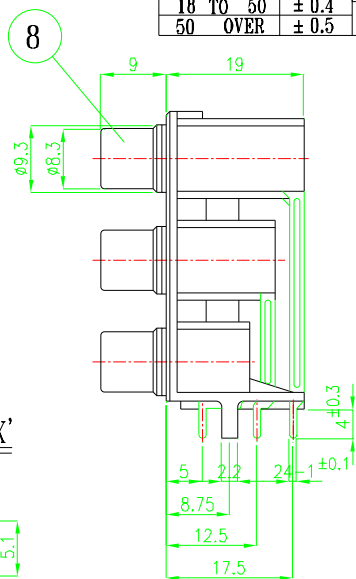
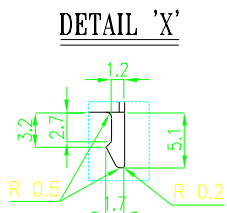
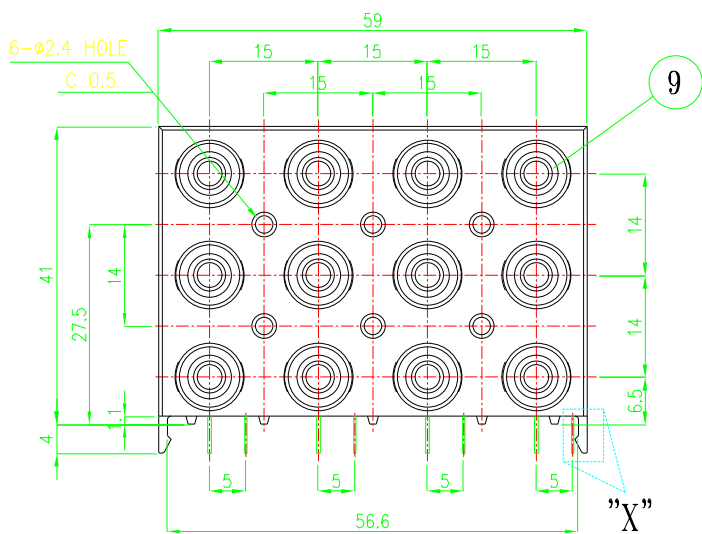
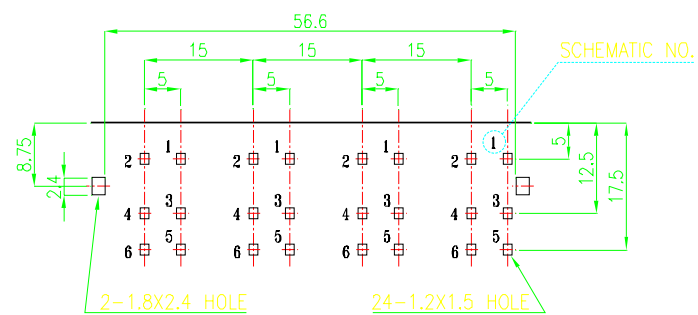
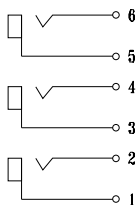

WASHER COLOR

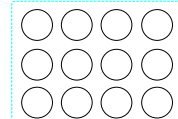

9	WASHER	ABS	94HB	12	2M634	
8	CAP	C2600	1-0	0.3t	12	1P065
7	PIN-S	C2680	1/2H	0.5t	4	2P288
6	PIN-M	C2680	1/2H	0.5t	4	2P287
5	PIN-L	C2680	H	0.5t	4	2P286
4	GND TER'-S	C2680	1/2H	0.3t	4	2P315
3	GND TER'-M	C2680	1/2H	0.3t	4	2P314
2	GND TER'-L	C2680	1/2H	0.3t	4	2P313
1	BASE	ABS	94HB	1	2M872	
NO	PART NAME	MATERIAL	QUANTITY	PART NO	REMARKS	

-PLATING
SnPb-PLATING
SnPb-PLATING
SnPb-PLATING
SnPb-PLATING
SnPb-PLATING
SnPb-PLATING
BLACK

Vimex International Corp.
800-227-0075

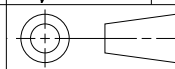

SCALE 1/1 DIMENSION m/m

REVISION	DRAWING	CHECKED	APPROVED
1.1	LMS		
	2002.03.19	2002.03.19	2002.03.19

NAME TITLE
DRAWING NUMBER
PIN JACK BOARD(12P)
JB120154