

ALLOWANCE	MARK	DATE	DESCRIPTION OF REVISION	APPROVED
UNDER 3	± 0.1	△		
3 TO 6	± 0.2	△		
6 TO 18	± 0.3	△		
18 TO 50	± 0.4	△		
50 OVER	± 0.5	△		

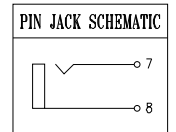

	MONO TYPE	SWITCH TYPE
	Circuit (Plug insert face)	Circuit (Plug insert face)
MODEL NO.		
WITHOUT SHIELD PLATE	C5016030 <input type="checkbox"/> <input type="checkbox"/>	C5016030 <input type="checkbox"/> <input type="checkbox"/>
WITH SHIELD PLATE	C5016030 <input type="checkbox"/> <input type="checkbox"/>	C5016030DG

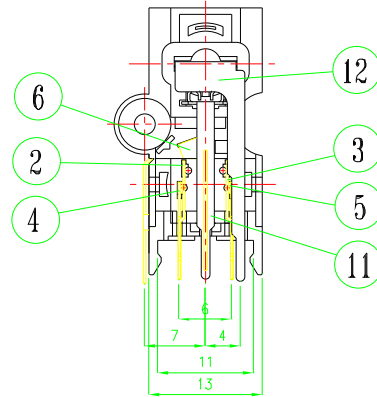
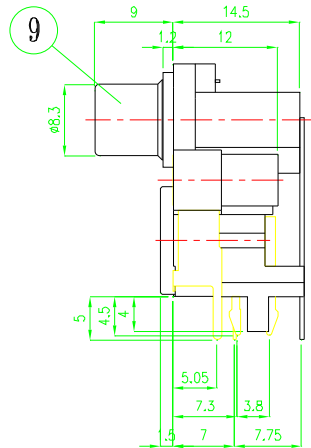
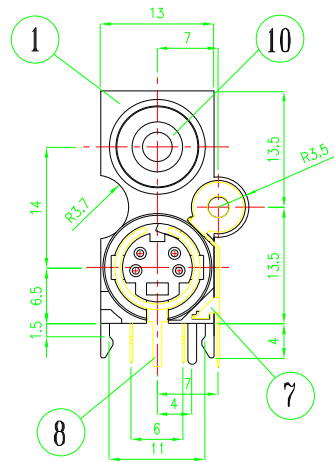
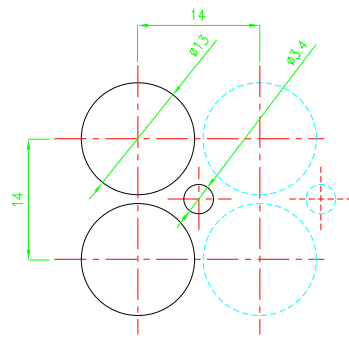
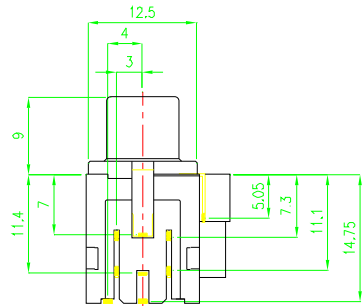

PANEL MOUNT HOLE

12	PIN-L	C2680 H	0.5L	1	2P041	NI-PLATING
11	TERMINAL	C2680 1/2H	0.3L	1	2P365	NI-PLATING
10	WASHER	ABS	94HB	1	2M616	YELLOW
9	CAP	C2600 1-0	0.3L	1	1P065	NI-PLATING
8	CAP GROUND	C2680 1/2H	0.35L	1	1P413	SnPb-PLATING
7	SHIELD PLATE	C2680 1/2H	0.3L	1	2P412	SnPb-PLATING
6	SWITCH TER'	C5210 H	0.2L	1	2P411	SnPb-PLATING
5	TER'-L	C5210 H	0.3L	1	2P410L	SnPb-PLATING
4	TER'-R	C5210 H	0.3L	1	2P410R	SnPb-PLATING
3	TER'-L	C5210 H	0.3L	1	2P409L	SnPb-PLATING
2	TER'-R	C5210 H	0.3L	1	2P409R	SnPb-PLATING
1	BASE	NORYL		1	2M795	BLACK
NO	PART NAME	MATERIAL	QUANTITY	PART NO	REMARKS	

Vimex International Corp.					SCALE	1/1	DIMENSION	m/m
REVISION	DRAWING	CHECKED	APPROVED	NAME TITLE	S-VHS JACK(1P) + PIN JACK(1P)			
1.0	L.M.S	B. Emmerich		DRAWING NUMBER	C5016030DG			
	1999.5.18	1999.5.18	1999.5.18					

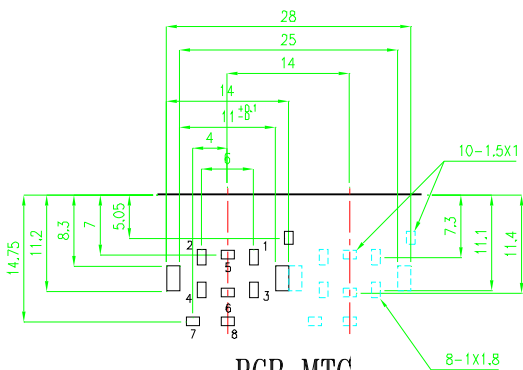

PCB MTG  
(SOLDER SURFACE)

