

**9mm Snap-In Insulated Shaft Potentiometer
with metal bushing
(non-threaded)**

SIS09VC

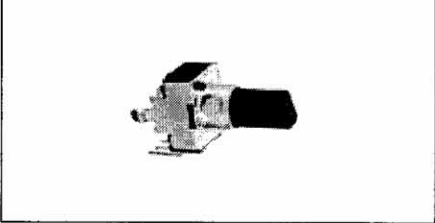

Part Number

SIS09VC - **B** **50K**, L - **20** **KC**
 Taper Resistance Value Shaft Type
 Shaft Length

Dimensions

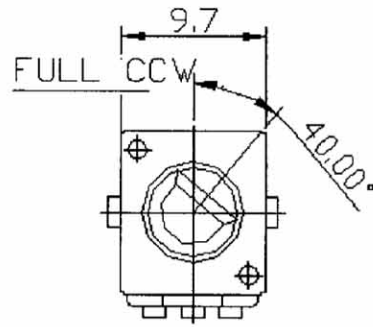
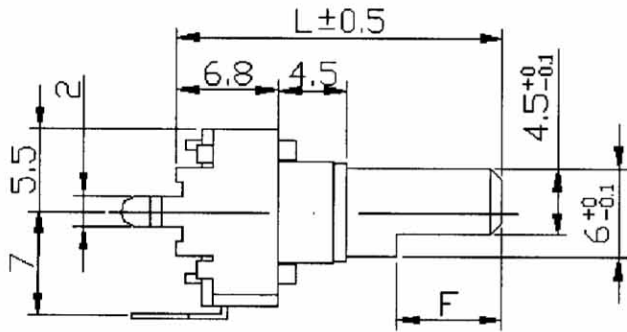

P.C.B LAYOUT

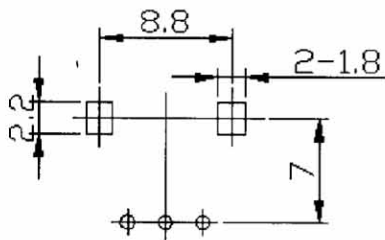

CIRCUIT

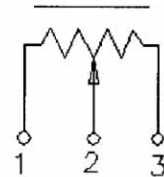

9mm Snap-In Insulated Shaft Potentiometer

Shaft Type

KC TYPE:

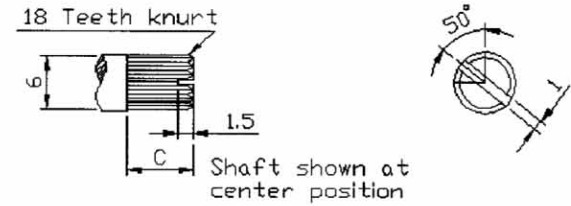

18 Teeth knurl
6
1.5
C
Shaft shown at center position
50°

L	15KC	20KC	25KC	30KC
KC	7	7		

KS TYPE:



24 teeth
4
S
C0.5

L	15KS	20KS	25KS	30KS	35KS
S	7	7	7	7	7

KQ TYPE:



40 teeth
6
Q
C0.5

L	15KQ	20KQ	25KQ	30KQ	35KQ
Q	6	7	7	7	7

KT TYPE:



40 teeth
6
T
C0.5

L	9KT	15KT	20KT	25KT	30KT
T	-	6	7		

F TYPE:

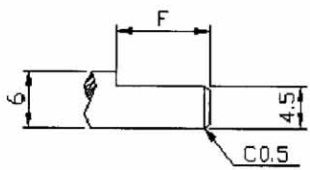

6
4.5
C0.5

L	15F	20F	25F	30F
F	6	7	12	12