

17mm Metal Shaft Rotary Potentiometer - With Switch

MS17HS



Part Number

MS17HS - **B** **50K**, L - **20** **KC**

↓ Taper ↓ Resistance Value ↓ Shaft Type
 ↓ With Switch ↓ Shaft Length

Dimensions

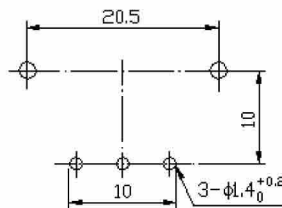
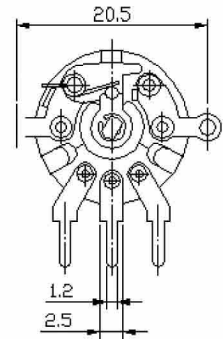
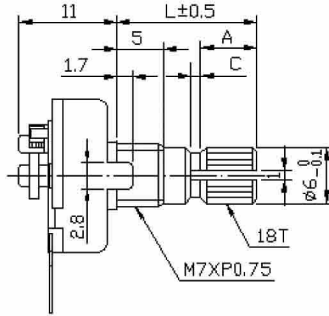

CIRCUIT

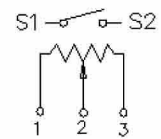

Shaft Type

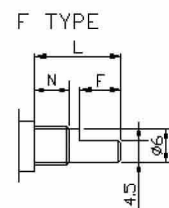
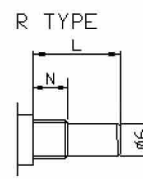
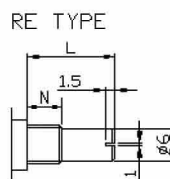
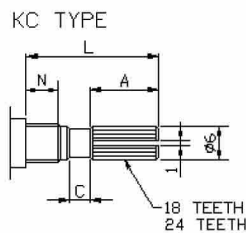

N:5m/m

SHAFT-TYPE	L	10	15	20	25	30	35	40
KC	A	3,2	6	10	12	12	12	12
	C	0,5	1	2	2	4	4	4
F	F	4	7	12	12	12	12	12
R,RE	L	10	15	20	25	30	35	40