

Product Drawing

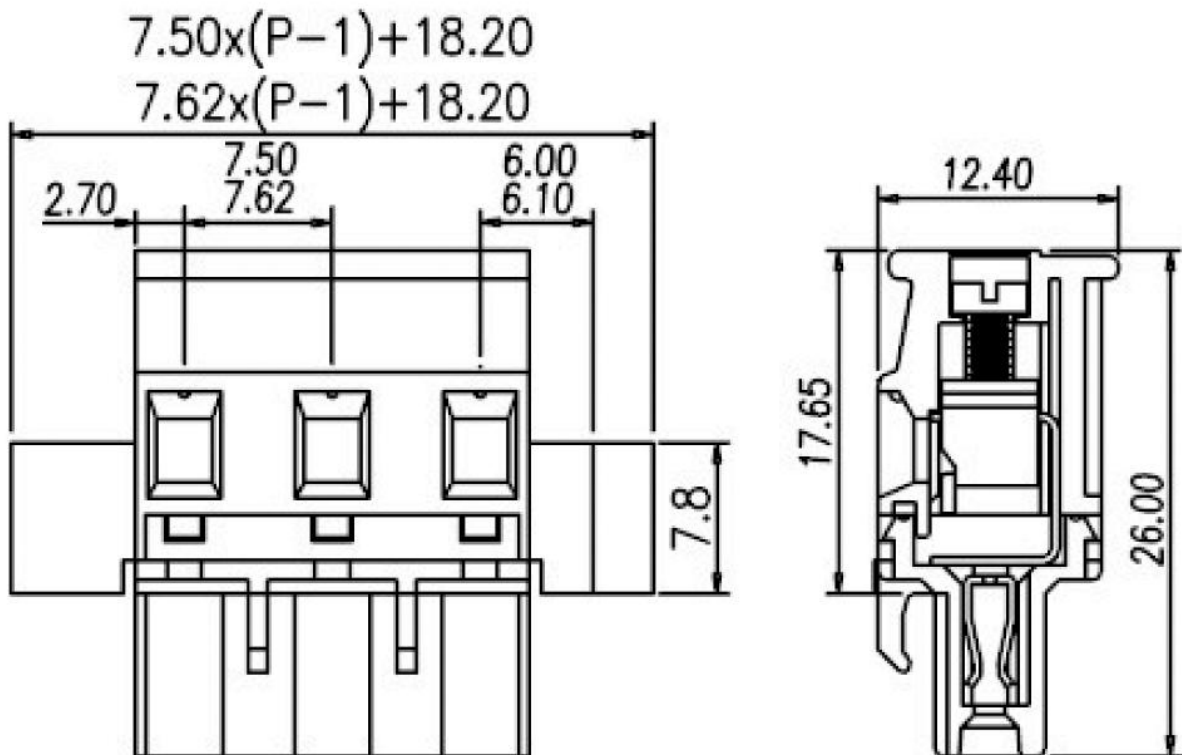

				Description:	Standard Outline Drawing
Page:	1	Date:	2010-12-14	P/N	VDGKAM-7.5 VDGKAM-7.62
of:	1	Revision:	1.0		