

Product Drawing

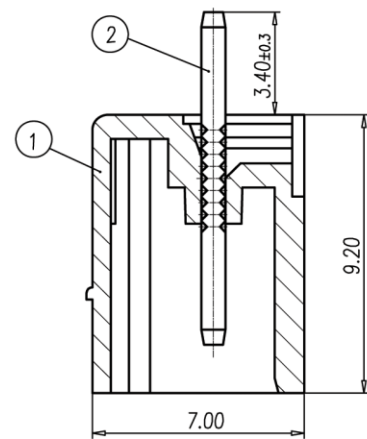

SECTION A-A

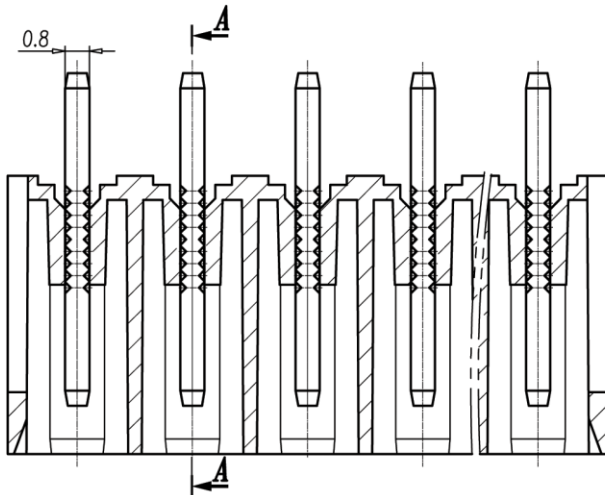
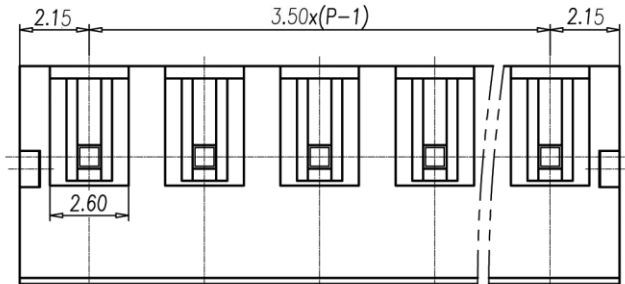
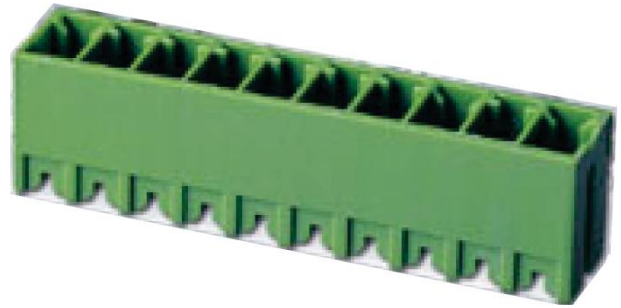
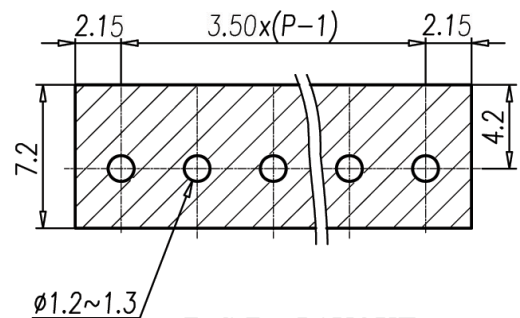
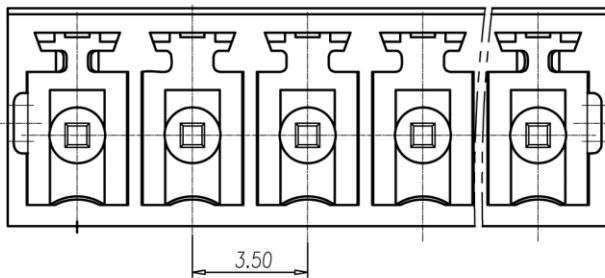

P.C.B. LAYOUT

Page:	1	Date:	2010-12-13	Description:	Standard Outline Drawing
of:	1	Revision:	1.0	P/N	VDECHV-3.5