

Product Drawing

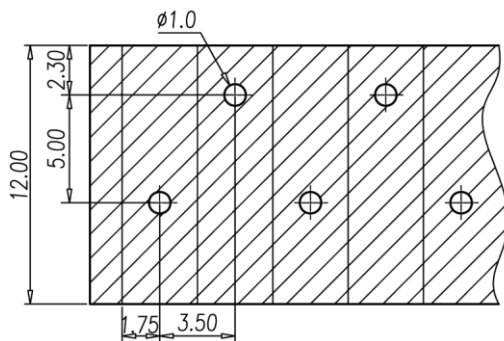

P.C.B. LAYOUT

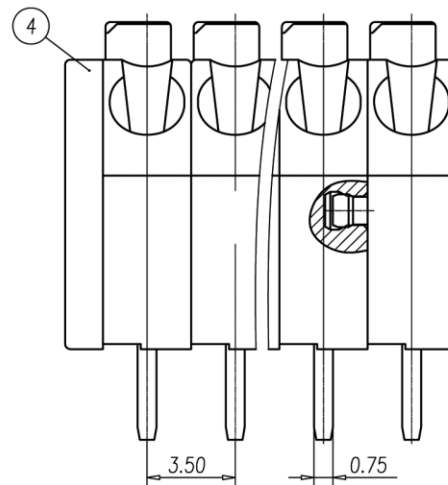
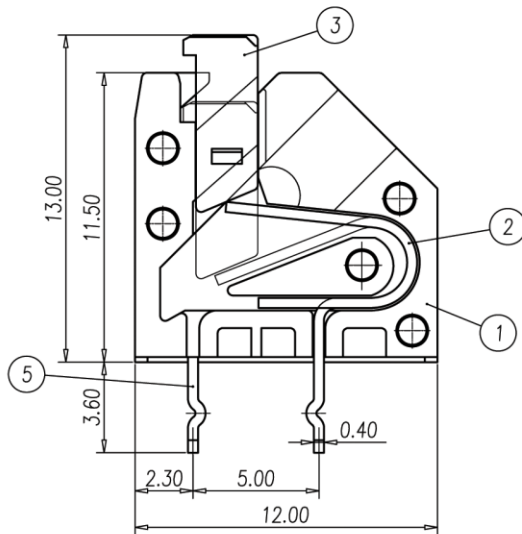
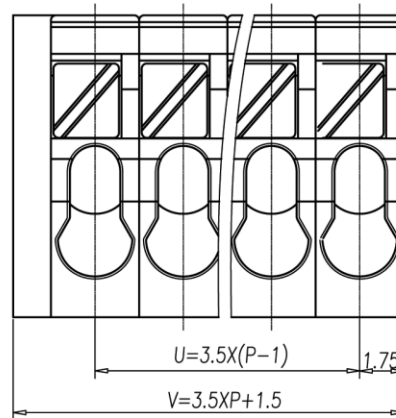

Page:	1	Date:	2011-01-13	Description:	Standard Outline Drawing
of:	1	Revision:	1.0	P/N	VNS13620-3.5